

HIGH SPEED BOREHOLE PUMP

in AISI 304



High speed borehole pumps in AISI 304

APPLICATIONS

- Domestic water supply systems (manufactured accordingly to TIFQ, ACS, WRAS and all the European certification for domestic drinking water)
- Small waterworks
- Irrigation and water pumping in general
- Water transferring
- Pressure boosting of clear water for agriculture, domestic or industrial use
- Adapting old unusable 4" water wells

TECHNICAL DETAILS

- Plug & Play - friendly usage
- Easy to handle and install
- Compact and robust construction
- High efficiency pump and motor
- Energy saving
- Additional controls may be installed
- "Soft start"
- Fully protected:
 - Over temperature protection
 - Dry-running protection
 - Over load protection
 - High/low voltage protection
 - Phase failure protection
 - Surge voltage protection

PERFORMANCE RANGE (according to ISO 9906 Attachment A)

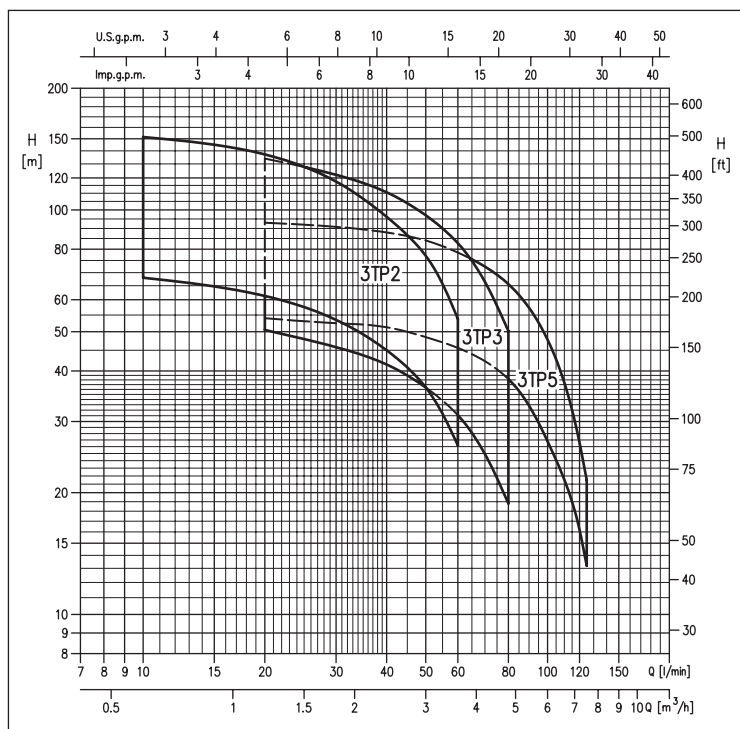

PUMP TECHNICAL DATA

- Maximum immersion: 150 m
- Maximum temperature of the liquid: 35°C
- Maximum presence of sand: 50 ppm
- Discharge connection: G1 (3TP 2 - 3TP 3), G1¼ (3TP 5)

MOTOR TECHNICAL DATA

- Insulation class: F
- Protection degree: IP 68
- 230V ±10% 50/60Hz single phase voltage
- For cables dimensioning please see page 58 or our Data Book on the web site www.ebara-europe.com

MATERIALS

- Shaft in AISI 304
- Impeller, intermediate stage and diffuser in noryl (PPO GF30)
- Suction and discharge in stainless steel EN 1.4308 (ASTM CF8)

ACCESSORIES (on request)

- Pressure switch

IDENTIFICATION CODE

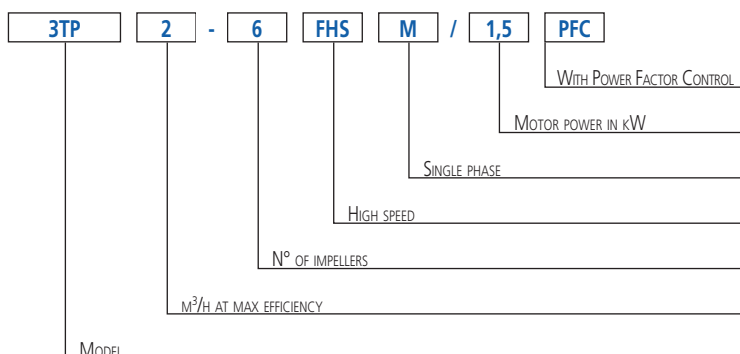



3TP

HIGH SPEED BOREHOLE PUMP in AISI 304

PERFORMANCE CURVES 3TP 2 series impeller diameter: 46 mm
(according to ISO 9906 Attachment A)

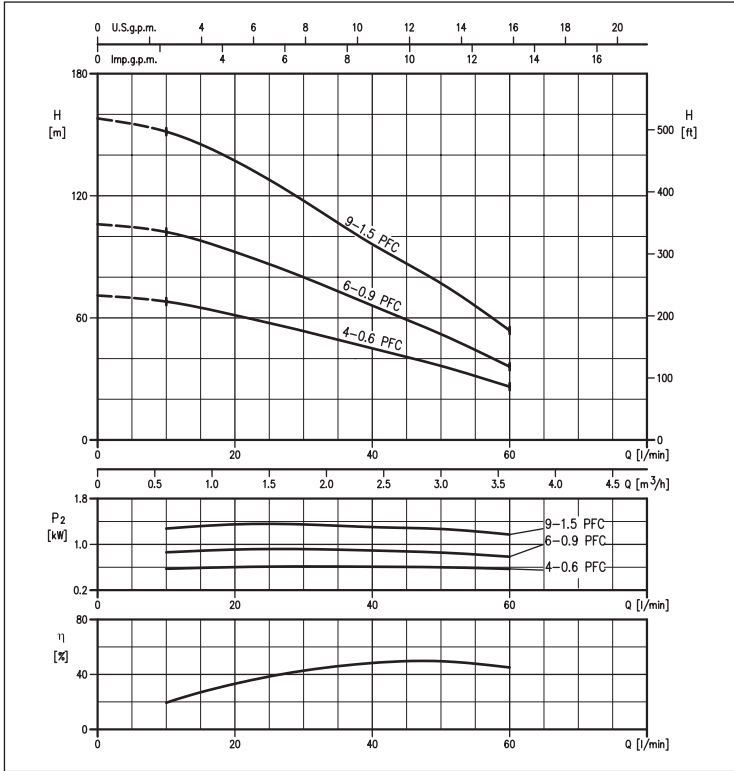

PERFORMANCE CURVES 3TP 3 series impeller diameter: 46 mm
(according to ISO 9906 Attachment A)

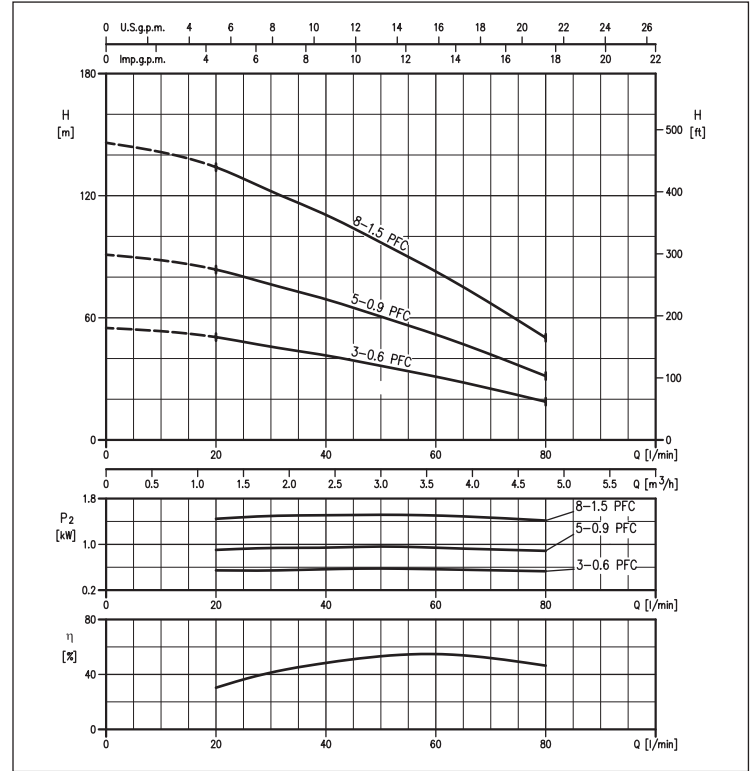

PERFORMANCE CURVES 3TP 5 series impeller diameter: 42 mm
(according to ISO 9906 Attachment A)

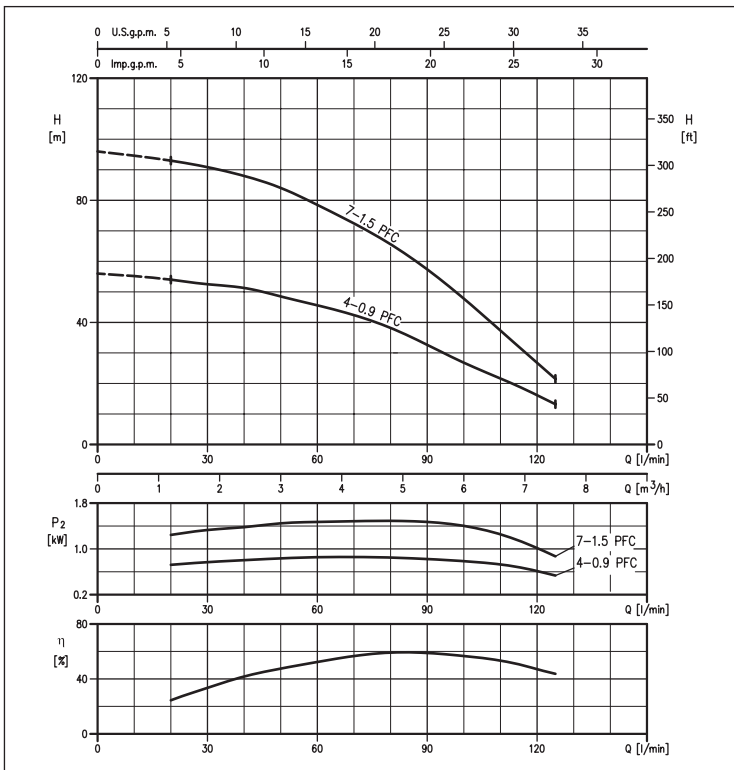

The contents of this publication must not be regarded as binding. EBARA Pumps Europe S.p.A. reserves the right to effect any modification it deems necessary, without prior notice.

HIGH SPEED BOREHOLE PUMP

in AISI 304

PERFORMANCE TABLE

Model	P:		Q=Flow rate										
	[HP]	[kW]	l/min m ³ /h	10 0,6	20 1,2	30 1,8	40 2,4	50 3,0	60 3,6	80 4,8	100 6,0	115 6,9	125 7,5
			H=Head [m]										
3TP2 4 PFC	0,8	0,6	68,0	61,0	54,0	45,0	36,0	26,0	-	-	-	-	-
3TP2 6 PFC	1,2	0,9	102,0	92,0	80,0	66,0	52,0	36,0	-	-	-	-	-
3TP2 9 PFC	2	1,5	152,0	137,0	118,0	96,0	77,0	54,0	-	-	-	-	-
3TP3 3 PFC	0,8	0,6	-	51,0	46,0	42,0	36,0	31,0	19,0	-	-	-	-
3TP3 5 PFC	1,2	0,9	-	84,0	76,0	69,0	61,0	52,0	31,0	-	-	-	-
3TP3 8 PFC	2	1,5	-	134,0	122,0	111,0	97,0	83,0	50,0	-	-	-	-
3TP5 4 PFC	1,2	0,9	-	54,0	53,0	51,0	49,0	46,0	38,0	27,0	19,0	13,0	-
3TP5 7 PFC	2	1,5	-	93,0	91,0	88,0	84,0	79,0	66,0	48,0	32,0	22,0	-

DIMENSIONS

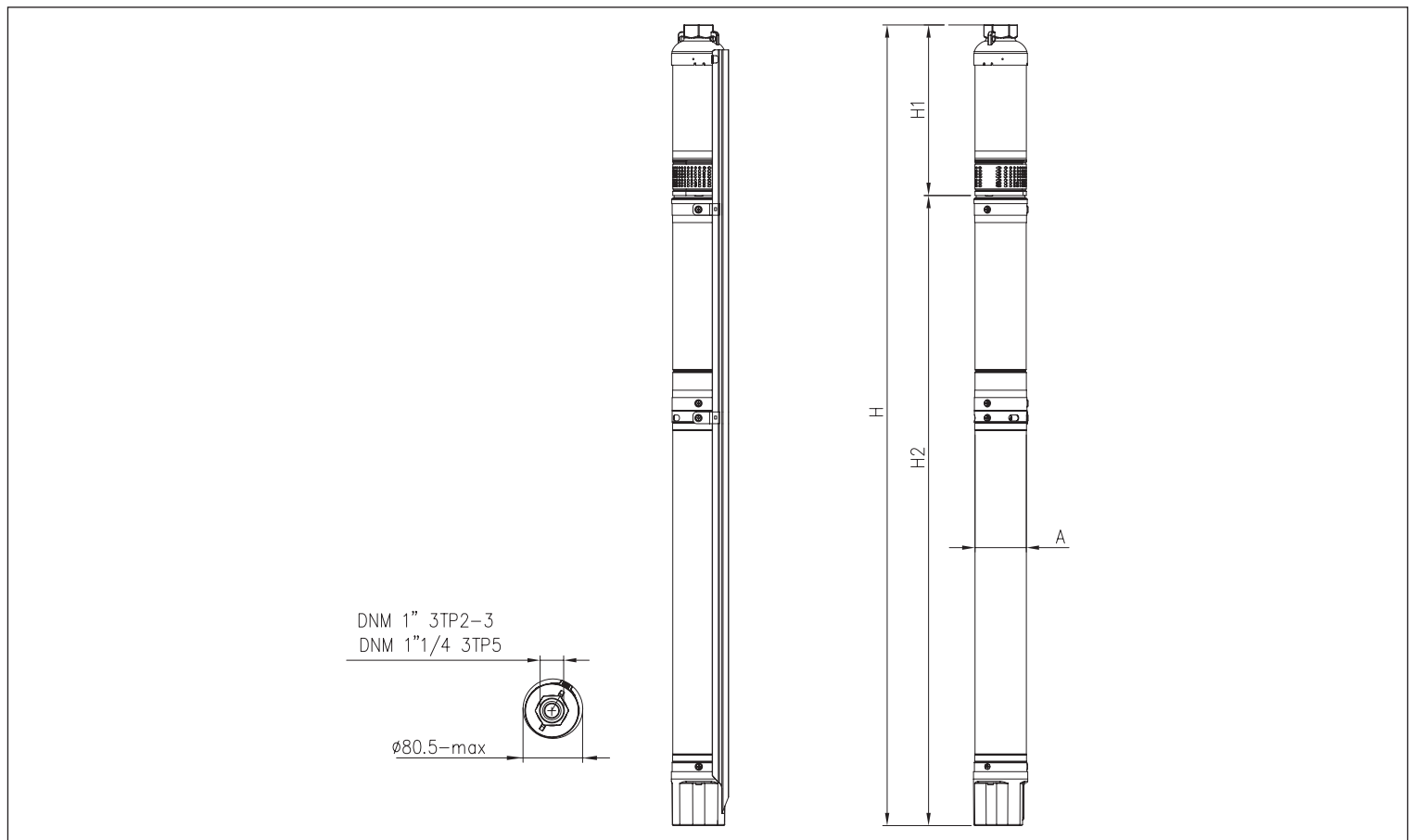

DIMENSIONAL TABLE

Model	P:		Pump without motor		A*	Pump + motor		Weight pump [kg]	Weight pump +motor [kg]
	[HP]	[kW]	H1 [mm]	DNM		H2 [mm]	H [mm]		
3TP2 4 PFC	0,8	0,6	255	G1	80	785	1040	1,4	10,3
3TP2 6 PFC	1,2	0,9	304	G1	80	815	1119	1,6	11,1
3TP2 9 PFC	2	1,5	377	G1	80	845	1222	1,9	12,1
3TP3 3 PFC	0,8	0,6	230	G1	80	785	1015	1,3	10,1
3TP3 5 PFC	1,2	0,9	279	G1	80	815	1094	1,5	11,0
3TP3 8 PFC	2	1,5	353	G1	80	845	1198	1,8	12,0
3TP5 4 PFC	1,2	0,9	277	G1¼	80	815	1092	1,5	11,0
3TP5 7 PFC	2	1,5	367	G1¼	80	845	1212	1,8	12,0

* Tolerance 0/+0,5mm

HIGH SPEED BOREHOLE PUMP in AISI 304

SECTIONAL VIEW

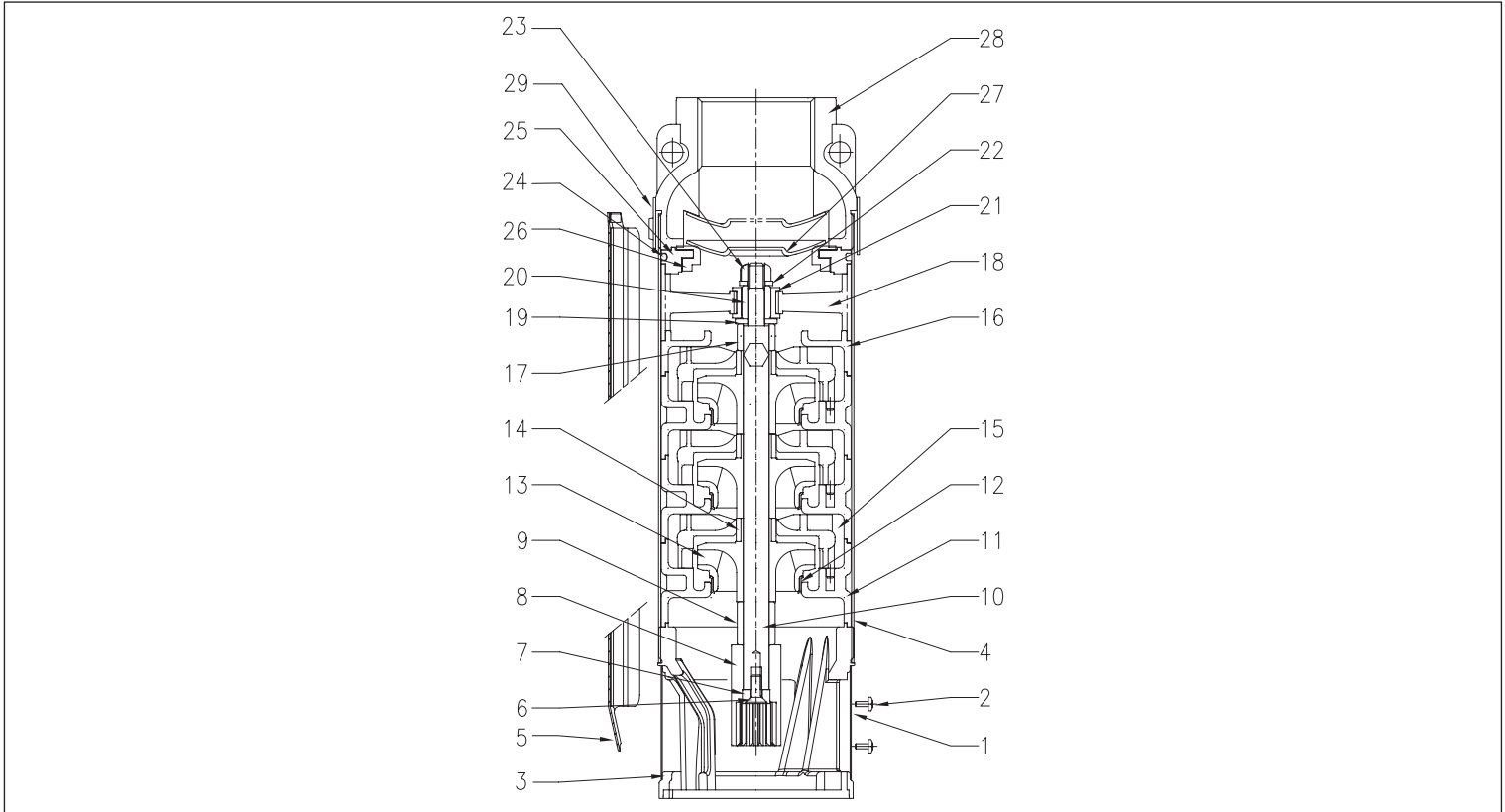

MATERIALS TABLE

Ref.	Name	Material	Ref.	Name	Material
1	Strainer	AISI 304	16	Stage cover	Noryl GF30
2	Screw	AISI 304	17	Spacer	Noryl GF30
3	Pump bracket	AISI 304	18	Upper bracket	Noryl GF30
4	External casing	AISI 304	19	Bearing washer	AISI 303
5	Isolating cover	AISI 304	20	Shaft casing (bearing)	Alumina
6	Screw	AISI 304	21	Bearing	NBR
7	Washer	AISI 304	22	Washer	AISI 304
8	Coupling splined	AISI 304	23	Nut	AISI 304
9	Spacer	Noryl GF30	24	O-Ring	NBR
10	Shaft	AISI 304	25	Valve seat	Noryl GF30
11	Stage housing	Noryl GF30	26	Valve seal ring	NBR
12	Wear ring	AISI 304	27	Valve disc	AISI 304
13	Impeller	Noryl GF30	28	Discharge bracket	AISI 304
14	Wear ring	Alumina	29	Cable cover holder(kit)	AISI 304
15	Diffuser	Noryl GF30			

ELECTRIC DATA TABLE 3TP WITH OIL FILLED MOTOR

P ₁		P ₂	Voltage	I _n	Efficiency	Power factor
[HP]	[kW]					
0,8	0,6	1,15	230V	5,9	52,2	0,9
1,2	0,9	1,49	230V	7,2	60,4	0,9
2	1,5	2,36	230V	11,4	63,6	0,9